



ZHANGJIAGANG ANNECY MACHINERY CO., LTD.

CATALOGUE & QUOTATION

Products Name	Model	Packaging volume (cm ³)	GW (kg)	NW (kg)	product specifications	产品图片 Product Picture
Electric hydraulic operating table	AC-OT001	138x70x86	325	261	<p>1、 Main Specification: Tabletop dimension: Overall length: 2040mm width : 500 mm Tabletop height: Min Height: 580 mm Max Height: 930mm Adujst: \geq 350mm</p> <p>2、 Technical parameter: Reversed Trendelenburg: \geq20°Trendelenburg: \geq15° Lateral tilt: \geq15° Head Section Up: \geq45°、 Down: \geq90° Back Section Up: \geq85°、 Down: \geq55° Leg Section Down:\geq90° Leg section opened:\geq90° Kidney section rise: \geq125mm Backward and Forward Movements:\geq300mm Horizonal rotation of tabletop:\geq180° *Electric hydraulic pump and electromagnetic valve are import parts</p>	



ZHANGJIAGANG ANNECY MACHINERY CO., LTD.

CATALOGUE & QUOTATION

Products Name	Model	Packaging volume (cm3)	GW (kg)	NW (kg)	product specifications	产品图片 Product Picture
Electric hydraulic operating table	AC-OT002				<p>1、 Main Specification: Overall length: 2100mm width : 500 mm Tabletop height: 710~1160mm Adujst: ≥450mm</p> <p>2、 Technical parameter: Backward and Forward Movements: ≥500mm Reversed Trendelenburg: ≥25°Trendelenburg: ≥20° Lateral tilt: ≥18° Head Section Up: ≥45°、 Down: ≥90° Back Section Up: ≥85°、 Down: ≥40° Leg Section Down: ≥90° Leg section opened: ≥90° Kidney section rise: ≥85mm V-shaped position: ≤100°, anti-V: ≤220° Safe working load: 135Kg Power: (AC) 220V±10%, 50Hz Rate: 450VA *Electric hydraulic pump and electromagnetic valve are import parts Power: (AC) 220V±10%, 50Hz</p>	



ZHANGJIAGANG ANNECY MACHINERY CO., LTD.

CATALOGUE & QUOTATION

Products Name	Model	Packaging volume (cm3)	GW (kg)	NW (kg)	product specifications	产品图片 Product Picture
Photography Bed	AC-OT003				Technical parameter Overall length: 2450mm width: 650mm perspective surface length: 1800mm Metal-free check length*width: 1450x460mm Minimum bed height: 800mm Adjust: ≥ 300 mm Lengthwise translation of tabletop: ≥ 800 mm transverse translation of tabletop: ≥ 200 mm	



ZHANGJIAGANG ANNECY MACHINERY CO., LTD.

CATALOGUE & QUOTATION

Products Name	Model	Packaging volume (cm3)	GW (kg)	NW (kg)	product specifications	产品图片 Product Picture
Electric hydraulic operating table	AC-OT004				<p>1、 Main Specification: Tabletop dimension: length: 2100mm width: 500mm Adjustable height range: 680~930mm Adjust ≥ 250mm can be up-down, fix freely</p> <p>2、 Technical parameter: Reversed Trendelenburg: $\geq 20^\circ$ Trendelenburg: $\geq 15^\circ$ Lateral tilt: $\geq 15^\circ$ Backward and Forward Movements: ≥ 250mm Head Section Up: $\geq 45^\circ$ Down: $\geq 90^\circ$ Back Section Up: $\geq 75^\circ$ Down: $\geq 10^\circ$ Leg Section Down: $\geq 90^\circ$ Leg section opened: $\geq 90^\circ$, Detachable Kidney section rise: ≥ 80mm Power: (AC) 220V$\pm 10\%$, 50HZ Safe working load: ≥ 135kg</p>	



ZHANGJIAGANG ANNECY MACHINERY CO., LTD.

CATALOGUE & QUOTATION

Products Name	Model	Packaging volume (cm3)	GW (kg)	NW (kg)	product specifications	产品图片 Product Picture
电手术台 Electric operating table	AC-OT005	150x78x103	325	261	<p>1、 Main Specification: Tabletop dimension: length: 2100mm width: 500 mm Adjustable height range: 750-1000mm Adjust \geq 250mm, Can be up-down, fix freely</p> <p>2、 Technical parameter: Reversed Trendelenburg: $\geq 25^\circ$ Trendelenburg: $\geq 25^\circ$ Lateral tilt: $\geq 15^\circ$ Head Section Up: $\geq 45^\circ$ Down: $\geq 90^\circ$ Back Section Up: $\geq 45^\circ$ Leg Section Down: $\geq 90^\circ$ Leg section opened: $\geq 90^\circ$, Detachable Foot Section and leg section are on the same horizontal line or on the vertical plane, detachable. Kidney section rise: ≥ 80mm Backward and Forward Movements: ≥ 400mm</p>	



ZHANGJIAGANG ANNECY MACHINERY CO., LTD.

CATALOGUE & QUOTATION

Products Name	Model	Packaging volume (cm ³)	GW (kg)	NW (kg)	product specifications	产品图片 Product Picture
Electric operating table	AC-OT006	145x78x98	325	261	<p>二、 Technical parameter</p> <p>1、 Tabletop dimension: Overall length: 2100mm width: 500mm</p> <p>2、 Tabletop height: Min Height: 750mm Max Height: 1000mm Adujst: ≥ 250mm, Can be up-down, fix freely</p> <p>3、 Reversed Trendelenburg: $\geq 20^\circ$ Trendelenburg: $\geq 15^\circ$ Lateral tilt: $\geq 15^\circ$ Head Section Up: $\geq 45^\circ$ Down: $\geq 90^\circ$ Back Section Up: $\geq 60^\circ$ Down: $\geq 30^\circ$ Leg Section Down: $\geq 90^\circ$ Leg section opened: $\geq 90^\circ$ Kidney section rise: ≥ 100mm Backward and Forward Movements: ≥ 250mm</p>	



ZHANGJIAGANG ANNECY MACHINERY CO., LTD.

CATALOGUE & QUOTATION

Products Name	Model	Packaging volume (cm3)	GW (kg)	NW (kg)	product specifications	产品图片 Product Picture
Electric operating table	AC-OT007	145x80x97	280	220	1、 Main specification: Overall length: 2100mm width: 500 mm Tabletop height: 700~950mm Adujst: ≥ 250 mm 2、 Technical parameter Reversed Trendelenburg: $\geq 20^\circ$ Trendelenburg: $\geq 20^\circ$ Lateral tilt: $\geq 18^\circ$ Head Section Up: $\geq 45^\circ$ Down: $\geq 90^\circ$ Back Section Up: $\geq 60^\circ$ Down: $\geq 10^\circ$ Leg Section Down: $\geq 90^\circ$ Leg section opened: $\geq 90^\circ$ Kidney section rise: ≥ 80 mm	



ZHANGJIAGANG ANNECY MACHINERY CO., LTD.

CATALOGUE & QUOTATION

Products Name	Model	Packaging volume (cm3)	GW (kg)	NW (kg)	product specifications	产品图片 Product Picture
Electric operating table	AC-OT008	150x78x103	325	261	<p>1、 Main specification: Tabletop dimension: Overall length: 2100mm width: 480 mm Adjustable height range: 750~1000mm Adujst: ≥250mm ,Can be up-down, fix freely</p> <p>2、 Technical parameter Reversed Trendelenburg: ≥25° Trendelenburg: ≥25° Lateral tilt: ≥15° Head Section Up: ≥45° Down:≥90° Back Section Up: ≥45° Down: ≥15° Leg Section Down:≥90° Leg section opened: ≥90°Detachable Foot Section can be 90 degree to the leg section and it's detachable. Kidney section rise: ≥100mm</p>	



ZHANGJIAGANG ANNECY MACHINERY CO., LTD.



CATALOGUE & QUOTATION

Products Name	Model	Packaging volume (cm3)	GW (kg)	NW (kg)	product specifications	产品图片 Product Picture
Electric operating table	AC-OT009	150x78x103	325	261	<p>1、 Main specification: Tabletop dimension: Overall length: 1980mm width: 500 mm Adjustable height range: 620~820mm Adujst: \geq 200mm, Can be up-down, fix freely</p> <p>2、 Technical parameter: Reversed Trendelenburg: \geq15° Trendelenburg: \geq20° Lateral tilt: \geq15° Head Section Up: \geq45° Down: \geq90° Back Section Up: \geq55° Down: \geq10° Leg Section Down: \geq90° Kidney section rise: \geq100mm</p>	



ZHANGJIAGANG ANNECY MACHINERY CO., LTD.

CATALOGUE & QUOTATION

Products Name	Model	Packaging volume (cm3)	GW (kg)	NW (kg)	product specifications	产品图片 Product Picture
电动手术台 Electric operating table	AC-OT010	141x76x83	200	150	1、 Main specification: Tabletop dimension: Overall length: 2000mm width: 480 mm Adjustable height range: 550~800mm Adujst: \geq 250mm Can be up-down, fix freely 2、 Technical parameter: Reversed Trendelenburg: \geq 20° Trendelenburg: \geq 20° Lateral tilt: \geq 18° Back Section Up: \geq 50° Down: \geq 15° Head Section Up: \geq 45° Down: \geq 90° Leg Section Down: \geq 90° Kidney section rise: \geq 100mm	 



ZHANGJIAGANG ANNECY MACHINERY CO., LTD.

CATALOGUE & QUOTATION

Products Name	Model	Packaging volume (cm3)	GW (kg)	NW (kg)	product specifications	产品图片 Product Picture
Multi-purpose Operating Table (Head controlled)	AC-OT011	138x76x107	280	220	<p>1、 Main specification:</p> <p>1.1 Tabletop dimension: Overall length: 2040mm width: 480 mm</p> <p>1.2 Adjustable height range: 740~940mm Adujst: ≥ 200mm ,Can be up-down, fix freely</p> <p>2、 Technical parameter:</p> <p>Reversed Trendelenburg: $\geq 50^\circ$ Trendelenburg: $\geq 30^\circ$</p> <p>Lateral tilt: $\geq 20^\circ$</p> <p>Head Section Up: $\geq 45^\circ$ Down: $\geq 90^\circ$</p> <p>Back Section Up: $\geq 80^\circ$ Down: $\geq 8^\circ$</p> <p>Leg Section Down:$\geq 90^\circ$</p> <p>Kidney section rise: ≥ 120mm</p> <p>Foot Section and leg section are on the same horizontal line or on the vertical plane.</p>	



ZHANGJIAGANG ANNECY MACHINERY CO., LTD.

CATALOGUE & QUOTATION

Products Name	Model	Packaging volume (cm3)	GW (kg)	NW (kg)	product specifications	产品图片 Product Picture
Multi-purpose Operating Table (Head controlled)	AC-OT012	138x76x107	280	220	<p>1、 Main specification: Tabletop dimension: Overall length: 2040mm width: 480 mm Adjustable height range: 800~1040mm Adujst: \geq 240mm ,Can be up-down, fix freely</p> <p>2、 Technical parameter: Reversed Trendelenburg: \geq50° Trendelenburg: \geq30° Lateral tilt: \geq20° Head Section Up: \geq45° Down: \geq90° Back Section Up: \geq80° Down: \geq8° Leg Section Down:\geq90° Leg Section Open:\geq90°,Detachable Foot section can be 90 degree to leg section,and it's detachable Kidney section rise: \geq120mm</p>	



ZHANGJIAGANG ANNECY MACHINERY CO., LTD.

CATALOGUE & QUOTATION

Products Name	Model	Packaging volume (cm3)	GW (kg)	NW (kg)	product specifications	产品图片 Product Picture
头部操纵式综合手术台 Multi-purpose Operating Table (Head controlled)	AC-OT013	141x76x114	290	230	1、 Main specification: Tabletop dimension: Overall length: 2040mm width: 480 mm Adjustable height range: 740~940mm Adujst: \geq 200mm ,Can be up-down, fix freely 2、 Technical parameter: Reversed Trendelenburg: \geq 50° Trendelenburg: \geq 30° Lateral tilt: \geq 20° Head Section Up: \geq 45° Down: \geq 90° Back Section Up: \geq 80° Down: \geq 8° Leg Section Down: \geq 90° Leg Section Open: \geq 90°,Detachable Foot section can be 90 degree to leg section,and it's detachable Kidney section rise: \geq 120mm	



ZHANGJIAGANG ANNECY MACHINERY CO., LTD.

CATALOGUE & QUOTATION

Products Name	Model	Packaging volume (cm ³)	GW (kg)	NW (kg)	product specifications	产品图片 Product Picture
Multi-purpose Operating Table (Side controlled)	AC-OT014	138x76x107	260	200	<p>1、 Main specification: Tabletop dimension: Overall length: 2100mm width: 500 mm Adjustable height range: 750~950mm Adujst: \geq 200mm ,Can be up-down, fix freely</p> <p>2、 Technical parameter: Reversed Trendelenburg: \geq20° Trendelenburg: \geq20° Lateral tilt: \geq18° Back Section Up: \geq55° Head Section Up: \geq45° Down: \geq90° Leg Section Down:\geq90° Leg Section Open:\geq90° Backward and Forward Movements:\geq400mm Kidney section rise: \geq120mm</p>	



ZHANGJIAGANG ANNECY MACHINERY CO., LTD.

CATALOGUE & QUOTATION

Products Name	Model	Packaging volume (cm ³)	GW (kg)	NW (kg)	product specifications	产品图片 Product Picture
Multi-purpose Operating Table (Side controlled)	AC-OT015	138x76x107	280	220	1、 Main specification: Tabletop dimension: Overall length: 2100mm width: 480 mm Adjustable height range: 740~940mm Adujst: \geq 200mm ,Can be up-down, fix freely 2、 Technical parameter: Reversed Trendelenburg: \geq 30° Trendelenburg: \geq 20° Lateral tilt: \geq 18° Head Section Up: \geq 45° Down: \geq 90° Back Section Up: \geq 75° Down: \geq 18° Leg Section Down: \geq 90° Kidney section rise: \geq 120mm	



ZHANGJIAGANG ANNECY MACHINERY CO., LTD.

CATALOGUE & QUOTATION

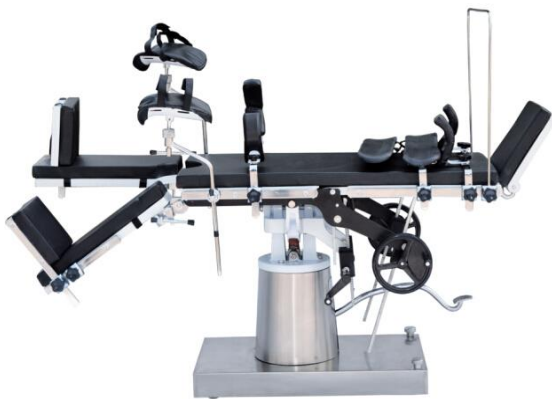
Products Name	Model	Packaging volume (cm3)	GW (kg)	NW (kg)	product specifications	产品图片 Product Picture
Multi-purpose Operating Table (Side controlled)	AC-OT016	138x76x107	280	220	<p>1、 Main specification: Tabletop dimension: Overall length: 2100mm width: 480 mm Adjustable height range: 740~940mm Adujst: \geq 200mm ,Can be up-down, fix freely</p> <p>2、 Technical parameter: Reversed Trendelenburg: \geq30° Trendelenburg: \geq20° Lateral tilt: \geq18° Back Section Up: \geq75° Down: \geq18° Head Section Up: \geq45°Down: \geq90°可伸长或拆卸 Leg Section Down:\geq90 Open\geq90°,detachable Kidney section rise: \geq120mm</p>	



ZHANGJIAGANG ANNECY MACHINERY CO., LTD.

CATALOGUE & QUOTATION

Products Name	Model	Packaging volume (cm ³)	GW (kg)	NW (kg)	product specifications	产品图片 Product Picture
Ordinary operating table	AC-OT017	138x76x99	172	108	1、 Main specification: Tabletop dimension: Overall length: 2000mm width: 480 mm Adjustable height range: 750~1000mm Adujst: ≥ 250 mm 2、 Technical parameter: Head Section Up: $\geq 45^\circ$ Down: $\geq 90^\circ$ Back Section Up: $\geq 45^\circ$ Down: $\geq 20^\circ$ Leg Section Down: $\geq 90^\circ$ Kidney section rise: ≥ 100 mm	



ZHANGJIAGANG ANNECY MACHINERY CO., LTD.

CATALOGUE & QUOTATION

Products Name	Model	Packaging volume (cm3)	GW (kg)	NW (kg)	product specifications	产品图片 Product Picture
Ophthalmology Operating Table	AC-OT018	140x76x87	200	140	1、 Main specification: Overall length: 1950mm width: 550mm Tabletop height: min height:530mm max height:780mm Adujst: 250mm Adjust of Head section : 100mm	



ZHANGJIAGANG ANNECY MACHINERY CO., LTD.

CATALOGUE & QUOTATION

Products Name	Model	Packaging volume (cm3)	GW (kg)	NW (kg)	product specifications	产品图片 Product Picture
普通产床 Ordinary Delivery Bed	AC-OT019	133x91x109	120	60	2、 Main specification: Tabletop dimension: Overall length:1900mm Width:600mm dimension of each section: Back section :750x600mm seat section :340x600mm leg section :750x600mm Table top height:780mm Adjustments of Sections: Back Section Up: $\geq 45^\circ$ Back Section Down: $\geq 7^\circ$ Seat Section Up: $\geq 25^\circ$ Seat Section Down: $\geq 8^\circ$ Leg Section Up: $\geq 25^\circ$ Leg Section Down: $\geq 25^\circ$	



ZHANGJIAGANG ANNECY MACHINERY CO., LTD.

CATALOGUE & QUOTATION

Products Name	Model	Packaging volume (cm ³)	GW (kg)	NW (kg)	product specifications	产品图片 Product Picture
妇科诊察床 Gynecological examination bed	AC-OT020	157x81x103	104	74	1、Main specification: Tabletop dimension: Overall length:1300mm Width:500 mm Height:750mm Back Section Up:≥30° Back Section Down:≥15°	



ZHANGJIAGANG ANNECY MACHINERY CO., LTD.

CATALOGUE & QUOTATION

Products Name	Model	Packaging volume (cm3)	GW (kg)	NW (kg)	product specifications	产品图片 Product Picture
骨科牵引架 Orthopedics traction frame	AC-OT021				Specification: length: $\geq 1200\text{mm}$ Two Traction Frame Pipes Opened: $\geq 60^\circ$ Traction Seat Displacement: $\geq 600\text{mm}$ Traction Distance: $\geq 200\text{mm}$ Height: 700~940mm : $\geq 550\text{mm}$	



ZHANGJIAGANG ANNECY MACHINERY CO., LTD.

CATALOGUE & QUOTATION

Products Name	Model	Packaging volume (cm3)	GW (kg)	NW (kg)	product specifications	产品图片 Product Picture
Orthopedics traction frame	AC-OT022				Specification: length: 1200mm width: 480mm height: 800~1030mm Traction Distance: ≥ 200 mm Traction Seat Displacement: ≥ 600 mm Leg Support Displacement: ≥ 550 mm Two Traction Frame Pipes Opened: $\geq 60^\circ$	